

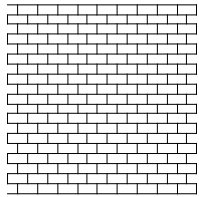

template catalog

Templates shown in this catalog are the most popular templates ordered.. For a more expansive library, shipping lead times, and pricing please visit our website at www.streetheat.com. For custom template options please call 1.800.331.8118

Popular Patterns



Offset Brick
Section 1.0

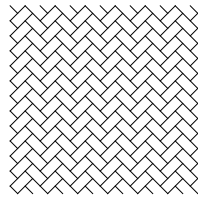

Diagonal Herringbone
Section 2.0

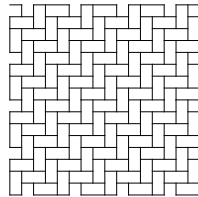

Standard Herringbone
Section 3.0

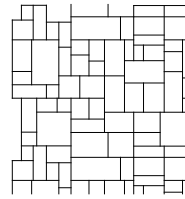

Ashlar Slate
Section 4.0

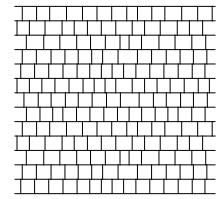

British Cobble
Section 5.0

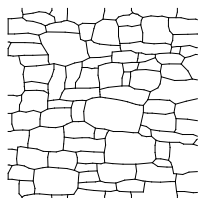

Stone Templates
Section 6.0

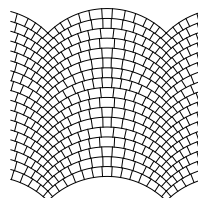

Eurofan Templates
Section 7.0

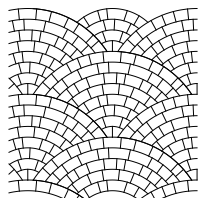

Scallop Templates
Section 8.0

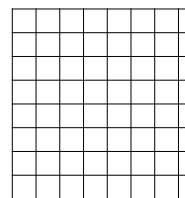

Tile Sets
Section 9.0

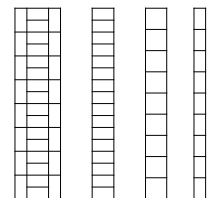

Border Templates
Section 10.0

Special Purpose

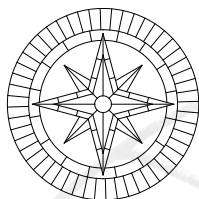

Accent Templates
Section 11.0

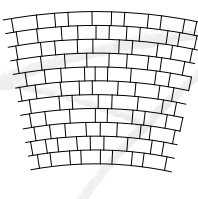

Radial & Arch Extensions
Section 12.0

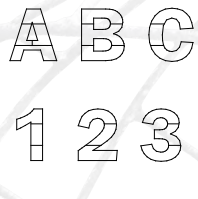

Numbers & Letters
Section 13.0

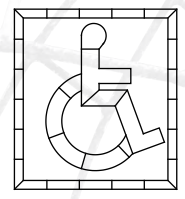

Signage & Playground
Section 14.0

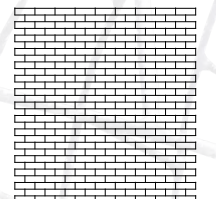

International Templates
Section 15.0

When you see these symbols

Interlocking

means template interlocks on one or more sides -standard practice with use of StreetHeat equipment

end-to-end

means template fits end to end - ideal for behind a paver or printing 2 templates at once

SR-120

template sized for a SR-120

SR-60

template sized for a SR-60

SR-20

template sized for a SR-20

paver

template can be used behind a paver

offset brick

Our newest version of the classic, offset brick patterned template, designed for optimal use with the **SR-120**. These templates can be used in the **StreetHeat®** and **TrafficPatternsXD®** applications. These templates allows for easy layout regardless of pattern direction.

Section

SR-120

all sides

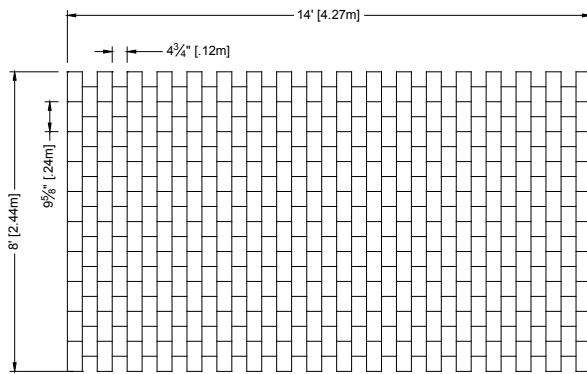

10-100

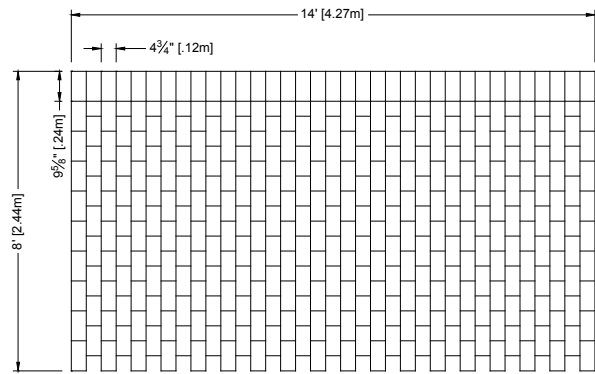

10-102

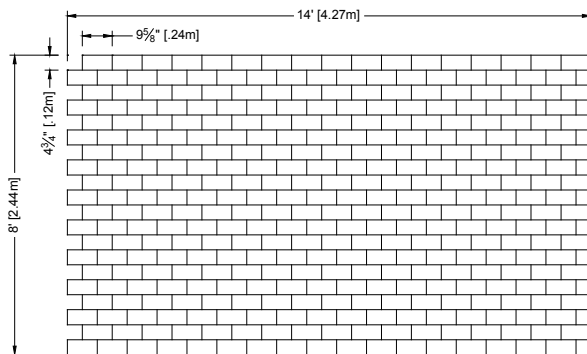

10-101

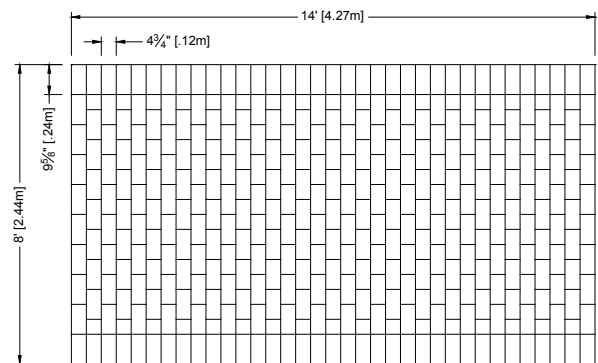

10-103

offset brick

The **SR-60** sized templates have been **optimized** to be used in the **StreetHeat®** and **TrafficPatternsXD®** applications. These templates allow for easy layout regardless of pattern direction.

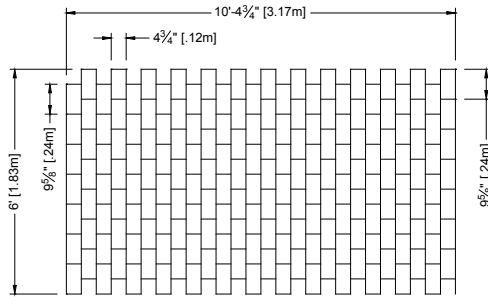

10-104

SR-60 all sides

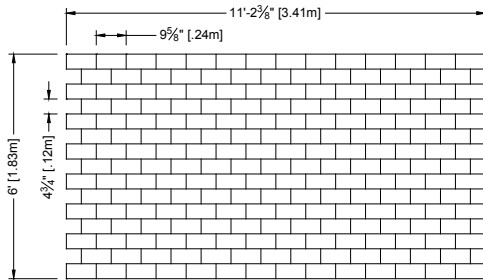

10-105

SR-60 all sides

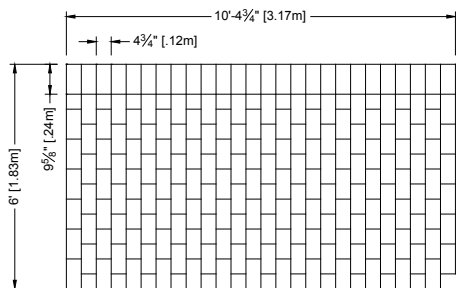

10-106

SR-60 all sides

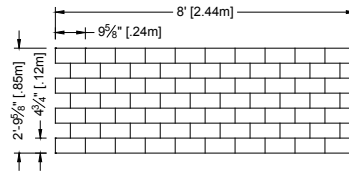

10-111

SR-20 all sides

Supporting Borders

any SR all sides

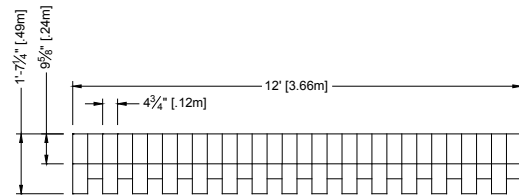

10-110

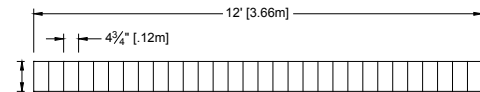

18-100

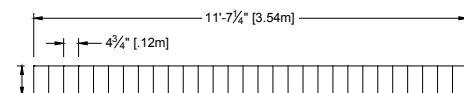

18-106

diagonal herringbone

This remarkably versatile, diagonal herringbone template is designed for optimal use with the **SR-120**. It can be used in either the **StreetHeat®** and **TrafficPatternsXD®** applications and it is compatible with the previous series of diagonal herringbone templates

Section
2.0

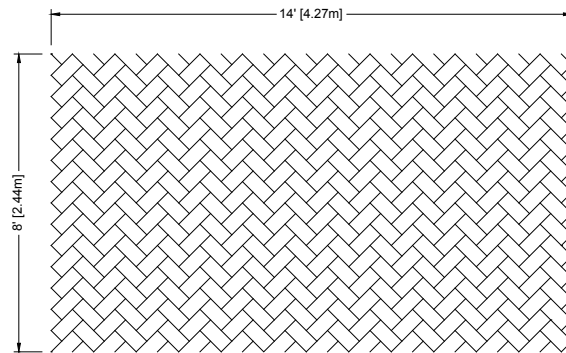

12-101

SR-120

14' sides only

all sides

Typical Brick Size: 4 7/8" [12.32m] x 9 3/4" [24.63cm]

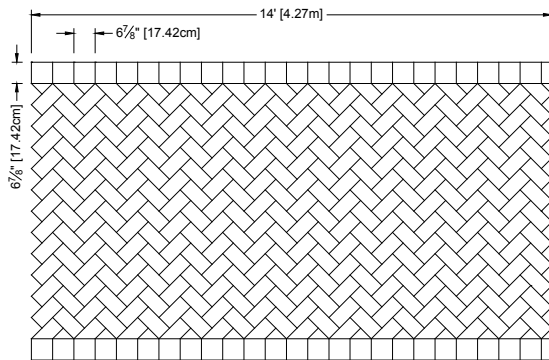

12-103

SR-120

all sides

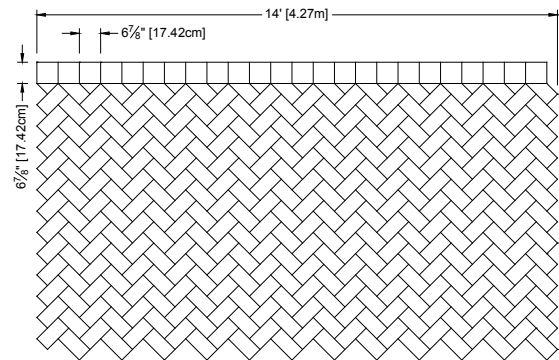

12-102

SR-120

all sides

diagonal herringbone

This remarkably versatile, diagonal herringbone template is designed for optimal use with the **SR-60**. It can be used in either the **StreetHeat®** and **TrafficPatternsXD®** applications and it is compatible with the previous series of diagonal herringbone templates

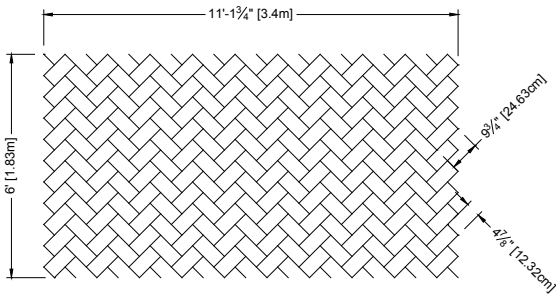

12-104

SR-60 11' sides only all sides

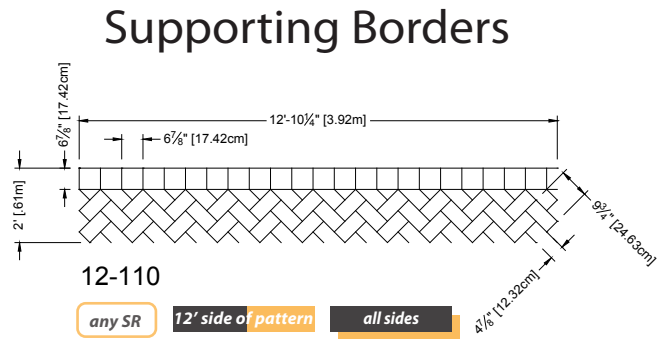

12-110

any SR 12' side of pattern all sides

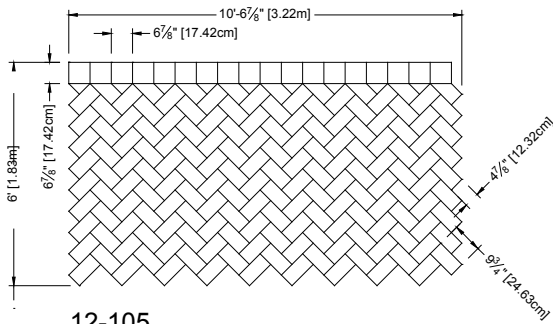

12-105

SR-60 all sides

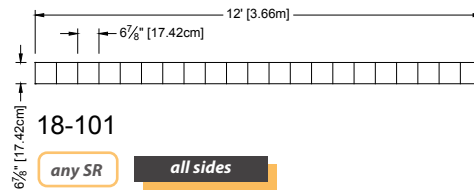

18-101

any SR all sides

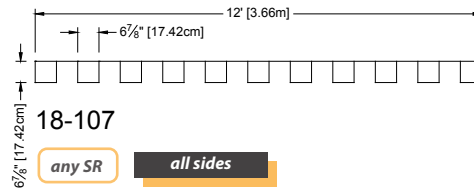

18-107

any SR all sides

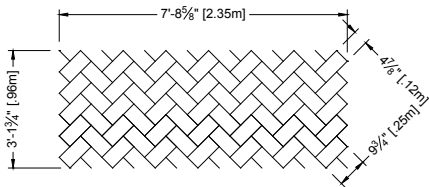

12-111

SR-20 7' side only all sides

standard herringbone

Classic standard Herringbone pattern designed to fit end-to-end **and** interlock on all sides

Section 3.0

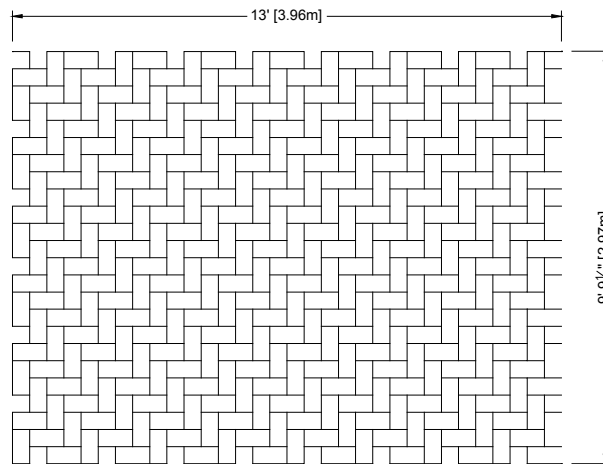

11-120-120

SR-120

all sides

all sides

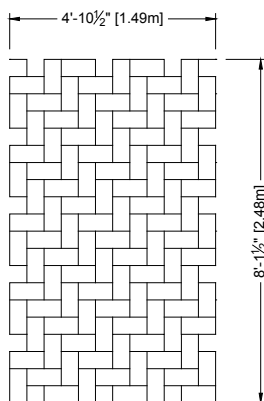

11-1-121

SR-60

all sides

all sides

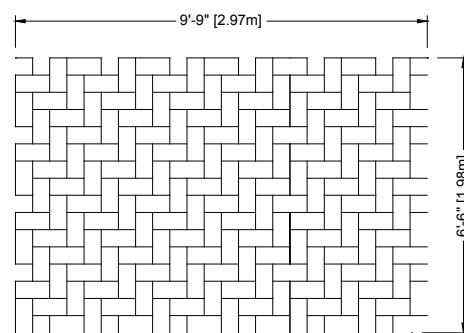

11-1-219

SR-60

all sides

all sides

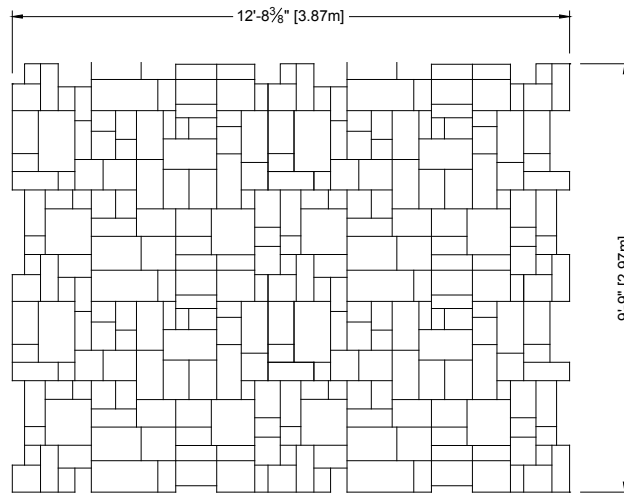

13-120-146

SR-120

all sides

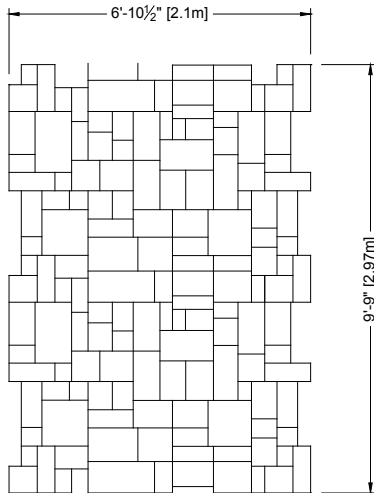

13-61-399

SR-60

all sides

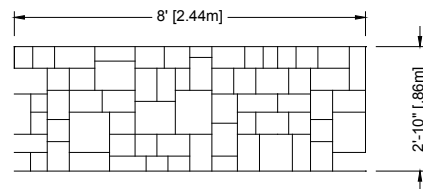

13-111

SR-20

3' sides only

british cobble

Section 5.0

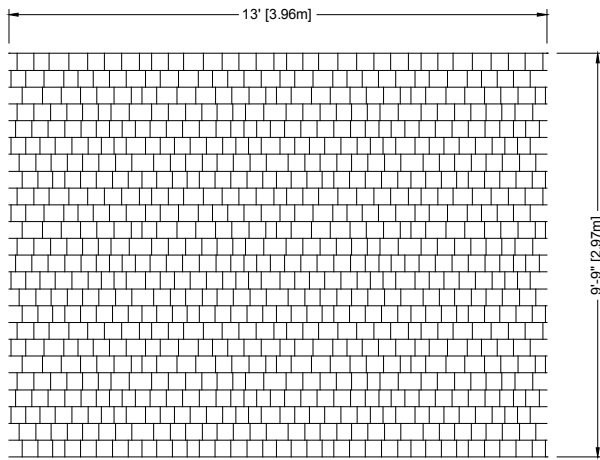

14-120-149

SR-120

all sides

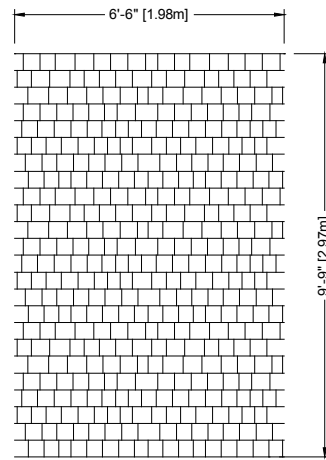

14-1-150

SR-60

all sides

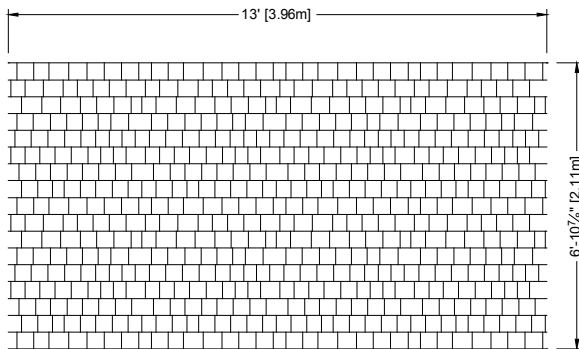

14-1-149

SR-120

7' sides

13' sides

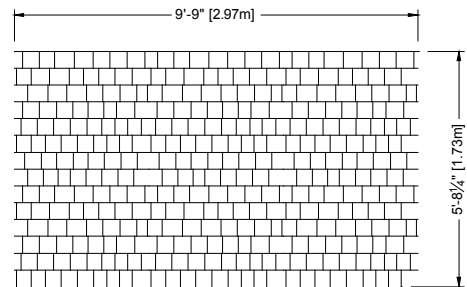

14-61-387

SR-60

all sides

stone templates

Random Slate

Section 6.0

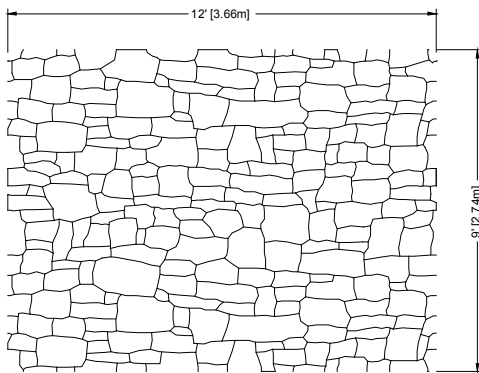

28-120-374

paver

SR-120

all sides

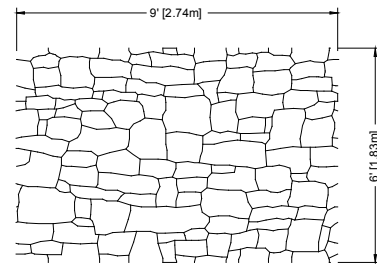

28-1-375

paver

SR-60

all sides

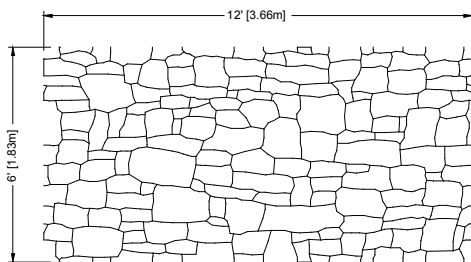

28-1-374

paver

SR-120

all sides

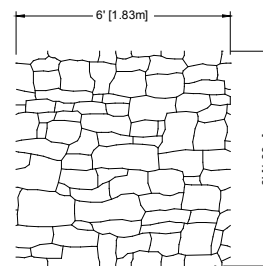

28-1-376

SR-60

all sides

stone templates

Section 6.1

Thompson
Stone

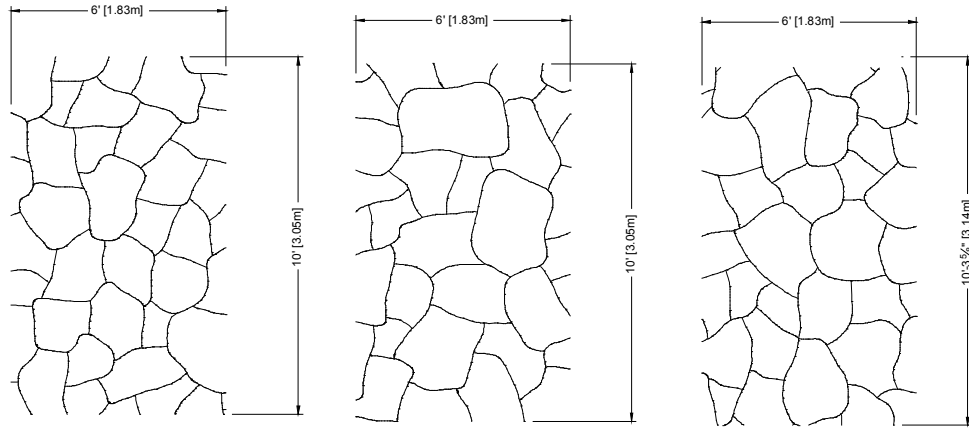

28-1-378 (set of 3)

paver

SR-60

all sides

Stone

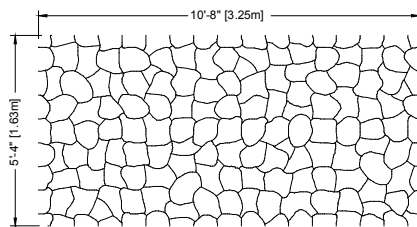

21-1-252

paver

SR-120

all sides

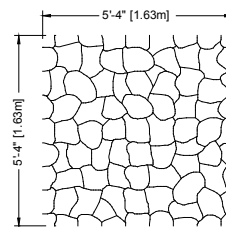

21-1-253

SR-60

all sides

Random Cobble

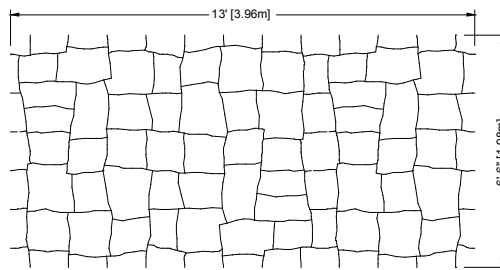

24-3-319

SR-120

paver

all sides

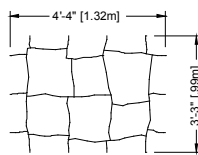
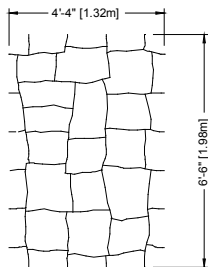

24-3-321

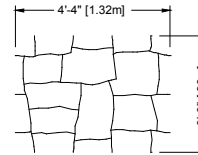

24-3-322

24-3-320

SR-60

all sides

eurofan templates

Section 7.0

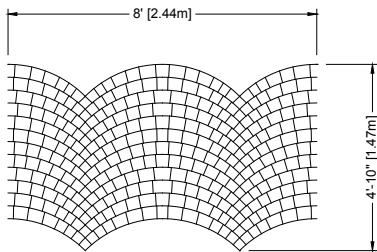

16-1-156

SR-60

4' sides only

8' sides, 2 rows

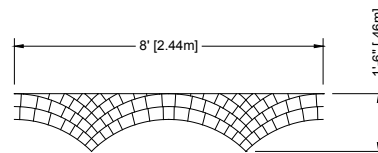

16-1-158 Top Edger

SR-60

SR-20

1' sides

8' side, curved wire

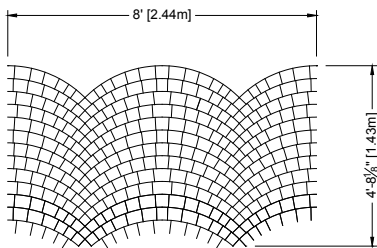

16-1-297

paver

SR-60

all sides

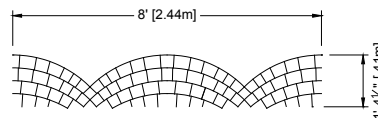

16-1-159 Bottom Edger

SR-60

SR-20

1' sides

8' side, curved wire

scallop templates

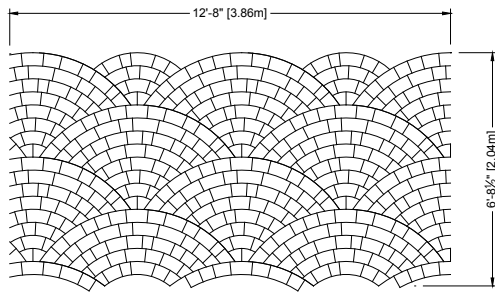

21-1-370

SR-120 6' sides only 12' sides, one row

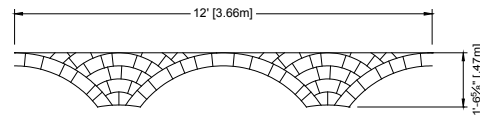

21-1-372 Top Edger

any SR 1' sides only 12' side, bottom row

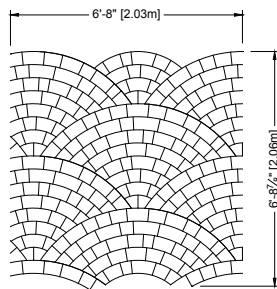

21-1-377

SR-60 6' sides only 6' sides, one row

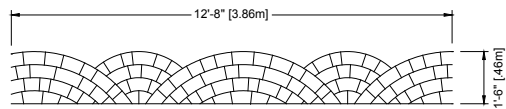

21-1-373 Bottom Edger

any SR 1' sides only 12' side, top row

4"
Tile

SR-60

all sides

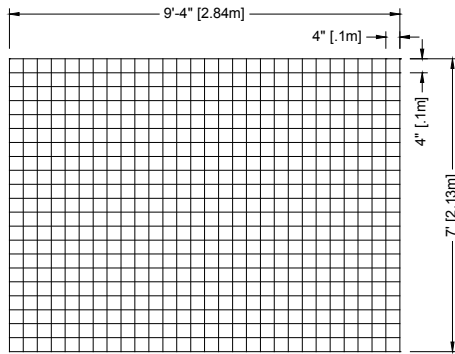

20-61-258

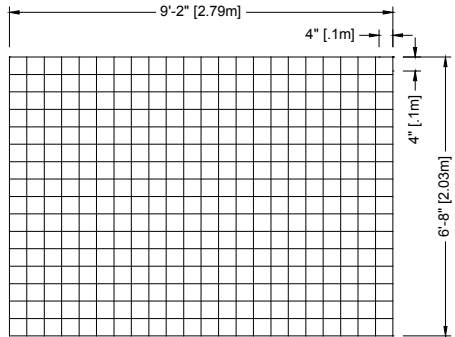

20-61-259

6"
Tile

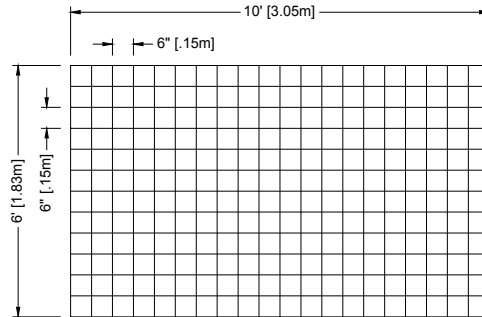

20-101

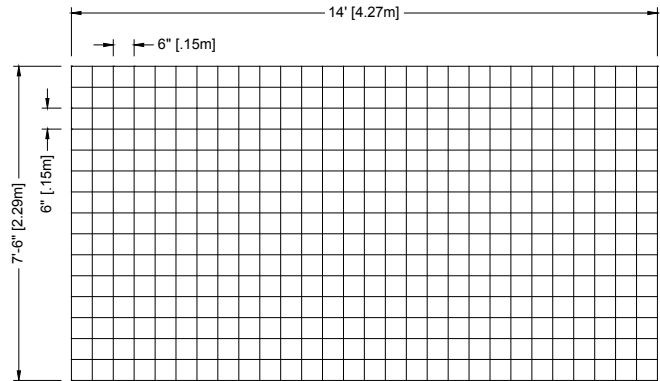

20-102

SR-120

all sides

5"
Tile

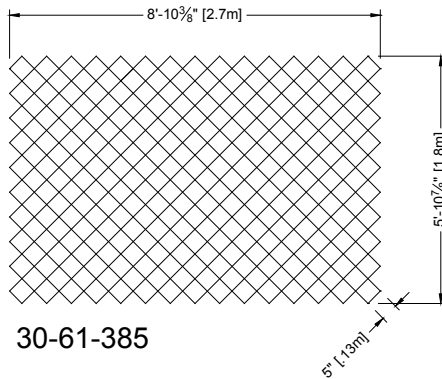

30-61-385

8"
Tile

10"
Tile

Section
9.1

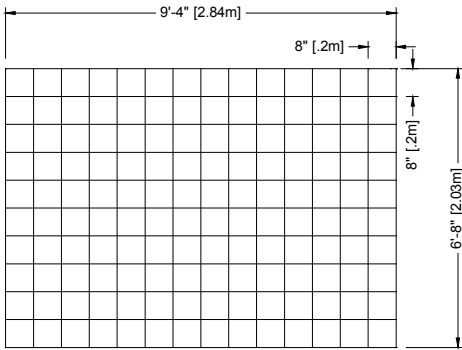

20-61-261

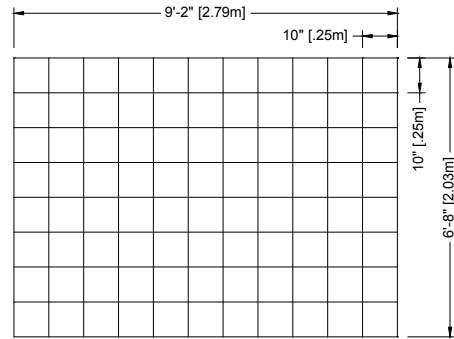

20-61-262

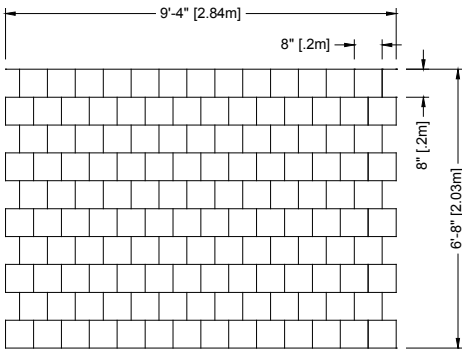

20-61-500

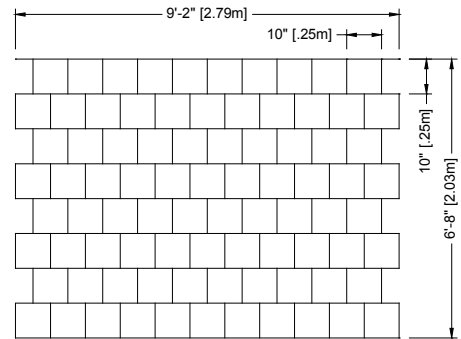

20-61-502

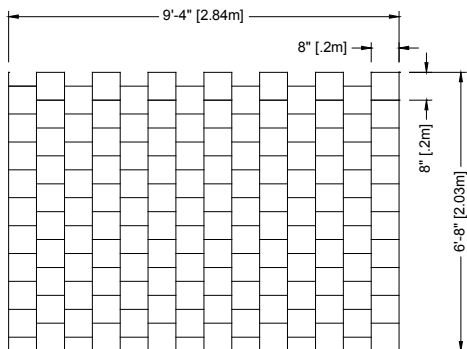

20-61-501

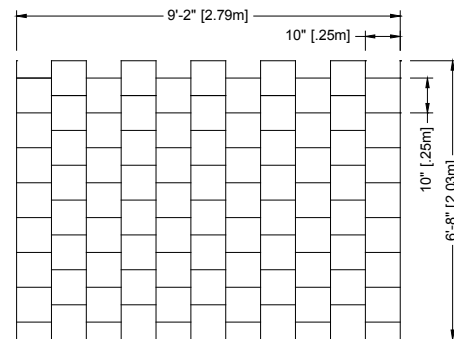

20-61-503

12"
Tile

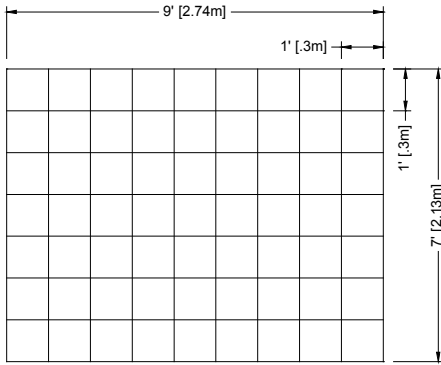

20-61-263

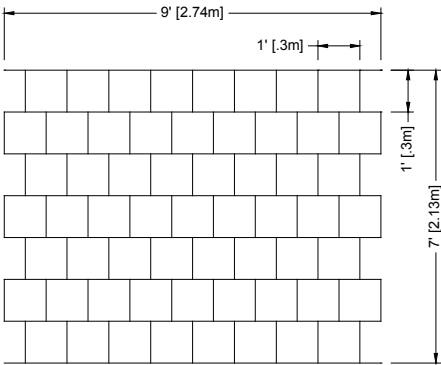

20-61-504

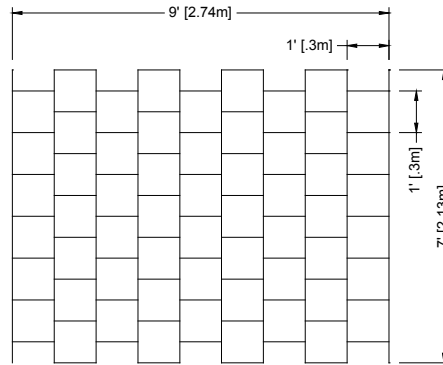

20-61-505

border templates

Section 10.0

any SR

all ends

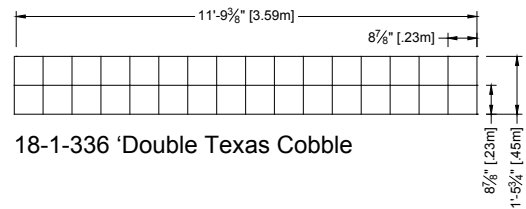
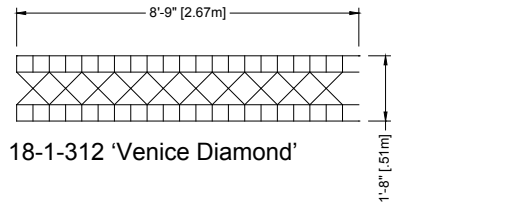
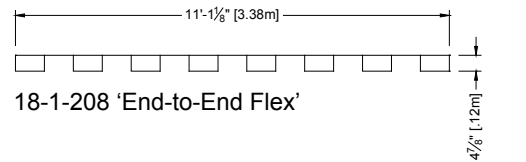
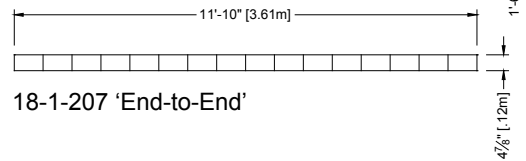
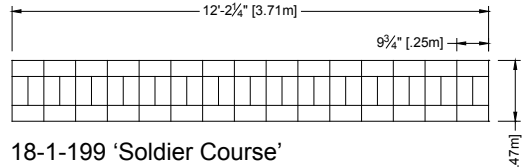
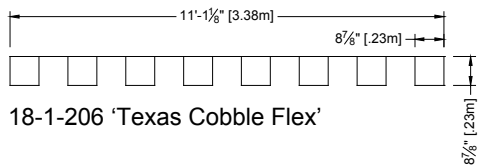
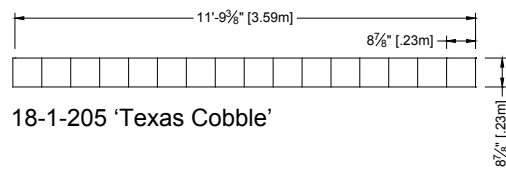
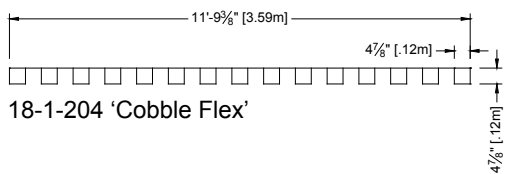
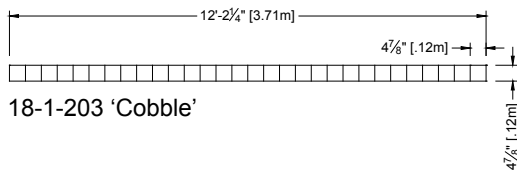
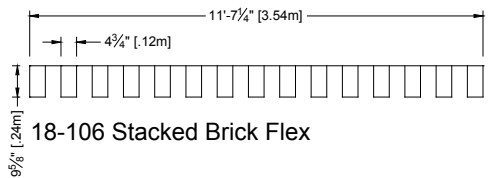
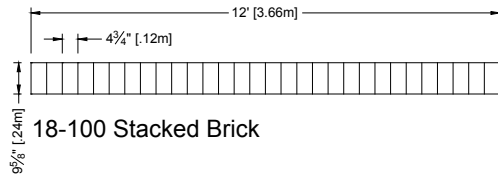

accent templates

Our new "Mini Accent" series was designed for the **SR-20** and to be inter-changeable with different borders and inserts to create different medallion combinations for driveways and or storefronts.

SR-20

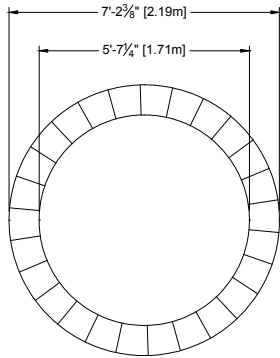

17-100
Texas Cobble Circle Border

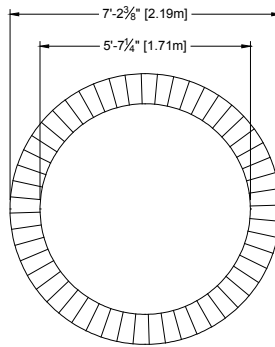

17-101
Stacked Brick Circle Border

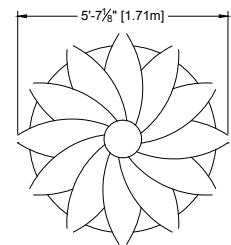

17-113
Pinwheel Insert

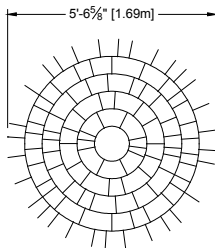

17-110
Cobble Insert

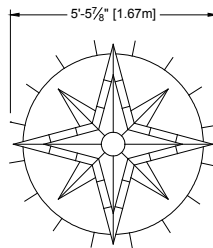

17-111
Compass Rose Insert

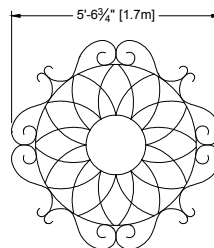

17-112
Ornate Rose Insert

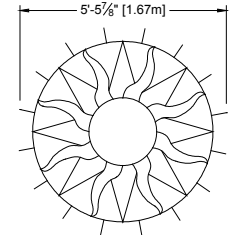

17-114
Sunburst Insert

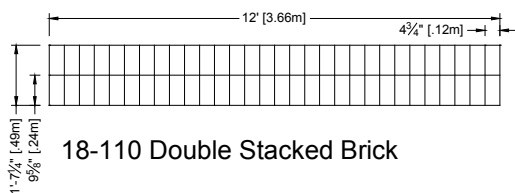

18-110 Double Stacked Brick

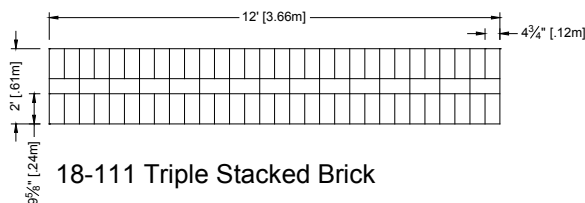

18-111 Triple Stacked Brick

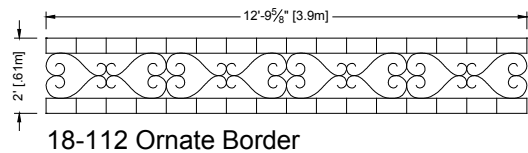

18-112 Ornate Border

Other compatible templates that may be used:

- 18-100 Stacked Brick Border
- 18-106 Stacked Brick Border Flex
- 18-1-205 Texas Cobble Border
- 18-1-206 Texas Cobble Border Flex
- 18-1-336 Double Texas Cobble Border
- 10-111 Offset Brick Pattern
- 12-111 Diagonal Herringbone Pattern
- 13-111 Ashlar Slate Pattern

radial & arch extensions

Section 12.0

SR-60

open sides

Product No.

17-1-162

Description

Large Circle 5' Radius

Brick Size

Random x $4\frac{7}{8}$ "
(12.4 cm)

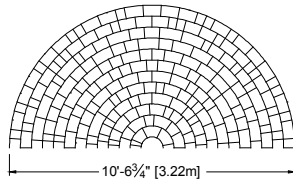

Product No.

17-1-163

Description

Medium Circle 3' Radius

Brick Size

Random x $4\frac{7}{8}$ "
(12.4 cm)

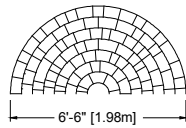

Product No.

17-1-269

Description

Arch Extension #3

Brick Size

Random x $4\frac{7}{8}$ "
(x 12.4cm)

Inside Rad.
15' [4.6m]

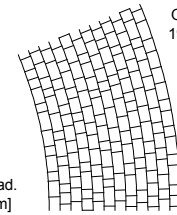

22.5 ° Section

Outside Rad.
19'-11" [6.1m]

Product No.

17-1-270

Description

Arch Extension #4

Brick Size

Random x $4\frac{7}{8}$ "
(x 12.4cm)

Inside Rad.
19'-11" [6.1m]

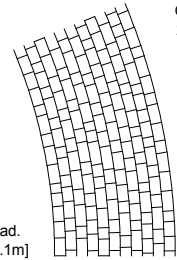

22.5 ° Section

Outside Rad.
24'-5" [7.4m]

For all Arch Extensions:

SR-60

open sides

last wire on curve

Product No.

17-1-244

Description

Arch Extension #1

Brick Size

Random x $4\frac{7}{8}$ "
(x 12.4cm)

Inside Rad.
5'-3" [1.6m]

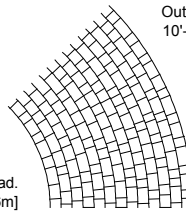

45 ° Section

Outside Rad.
10'-7" [3.2m]

Product No.

17-1-273

Description

Arch Extension #5

Brick Size

Random x $4\frac{7}{8}$ "
(x 12.4cm)

Inside Rad.
24'-5" [7.4m]

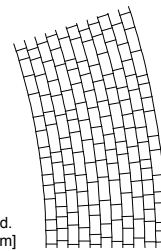

18 ° Section

Outside Rad.
28'-10" [8.8m]

Product No.

17-1-245

Description

Arch Extension #2

Brick Size

Random x $4\frac{7}{8}$ "
(x 12.4cm)

Inside Rad.
10'-7" [3.2m]

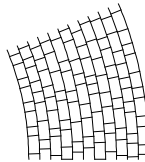

22.5 ° Section

Outside Rad.
15' [4.6m]

Product No.

17-1-274

Description

Arch Extension #6

Brick Size

Random x $4\frac{7}{8}$ "
(x 12.4cm)

Inside Rad.
28'-10" [8.8m]

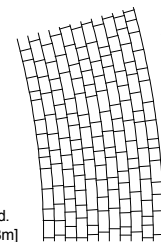

15 ° Section

Outside Rad.
33'-4" [10.2m]

radial & arch extensions

Section 12.1

Product No.
17-1-275

Description
Arch Extension #7

Brick Size
Random x 4⁷/₈"
(x 12.4cm)

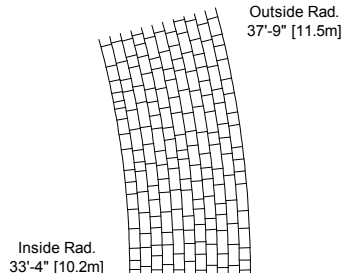

15 ° Section

Product No.
17-1-341

Description
Arch Extension #11

Brick Size
Random x 4⁷/₈"
(x 12.4cm)

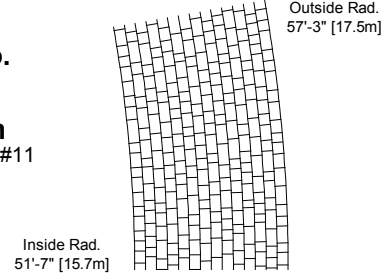

10 ° Section

Product No.
17-1-276

Description
Arch Extension #8

Brick Size
Random x 4⁷/₈"
(x 12.4cm)

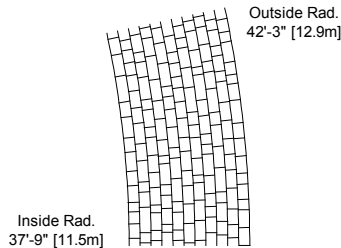

12 ° Section

Product No.
17-1-342

Description
Arch Extension #12

Brick Size
Random x 4⁷/₈"
(x 12.4cm)

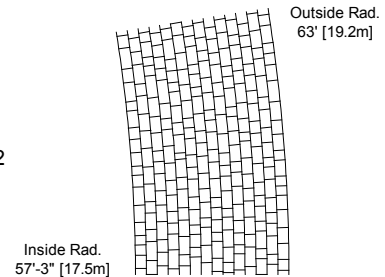

9 ° Section

Product No.
17-1-277

Description
Arch Extension #9

Brick Size
Random x 4⁷/₈"
(x 12.4cm)

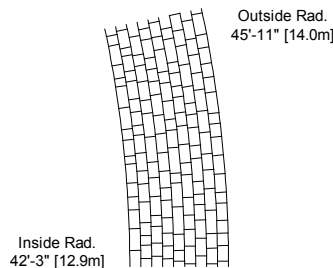

12 ° Section

Product No.
17-1-343

Description
Arch Extension #13

Brick Size
Random x 4⁷/₈"
(x 12.4cm)

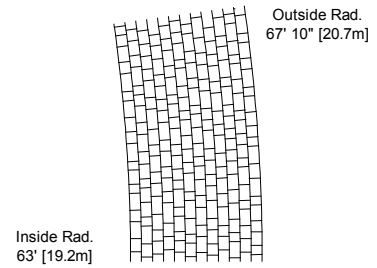

8 ° Section

Product No.
17-1-340

Description
Arch Extension #10

Brick Size
Random x 4⁷/₈"
(x 12.4cm)

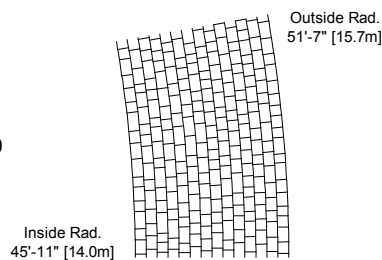

10 ° Section

Product No.
17-1-344

Description
Arch Extension #14

Brick Size
Random x 4⁷/₈"
(x 12.4cm)

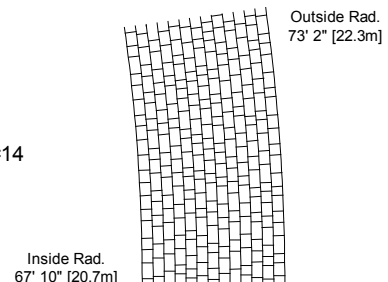

8 ° Section

numbers & letters

Section 13.0

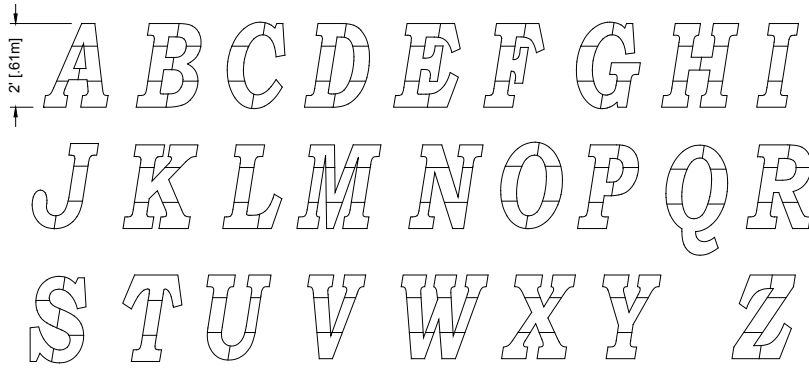

17-1-395 New Roman Letters - 24" tall

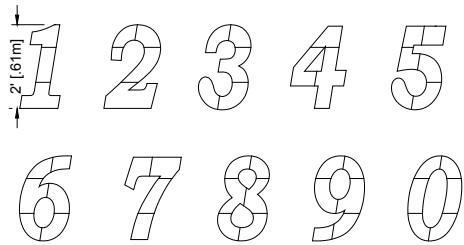

17-1-394 New Roman Numbers - 24" tall

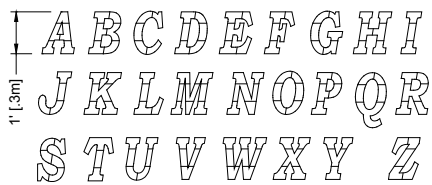

17-1-393 New Roman Letters - 12" tall



17-1-392 New Roman Numbers - 12" tall



17-1-391 Classic Letters - 12" tall

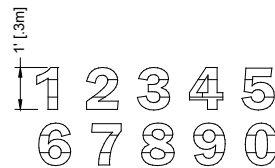

17-1-370 Classic Numbers - 12" tall

signage playground

SR-60

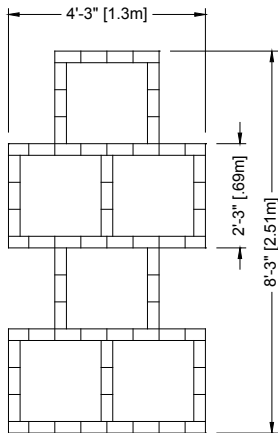

17-1-509 Hopscotch

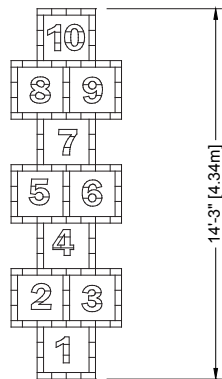

*Finished Layout with
17-1-178 (12" Classic Numbers)*

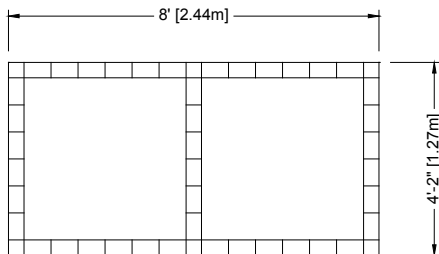

17-1-510 Four-Square

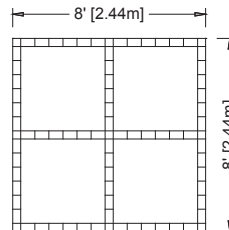

Finished Layout

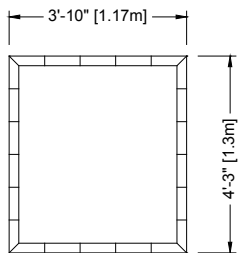

17-1-185 Signage Border

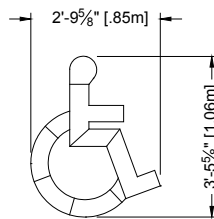

17-1-186 Wheelchair

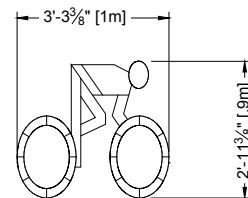

17-1-302 Bicycle

international templates

International templates are designed to match typical metric brick sizes

Section 15.0

21 x 10 cm Brick Size

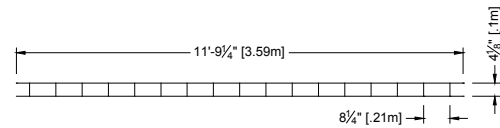
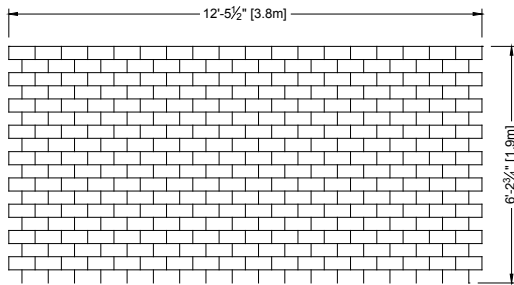

18-1-193 End-to-End Border

any SR 4" sides

10-113 Offset Brick

SR-120 12' sides all sides

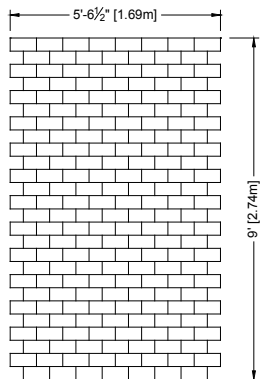

10-114 Offset Brick

SR-60 5' sides all sides

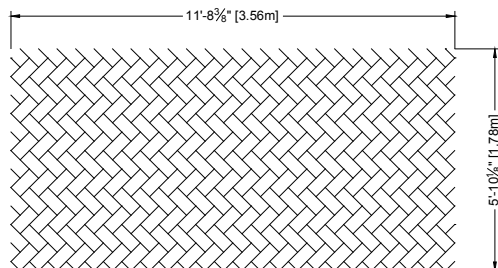

12-1-143 Diagonal Herringbone

SR-60 all sides all sides

(21 x 7 cm Brick Size)

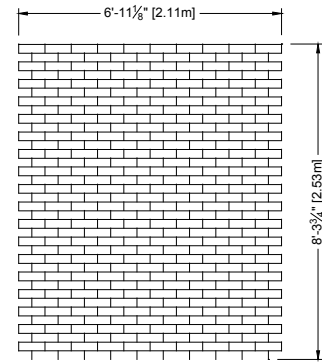

10-1-117 Offset Brick

SR-60 6' sides all sides

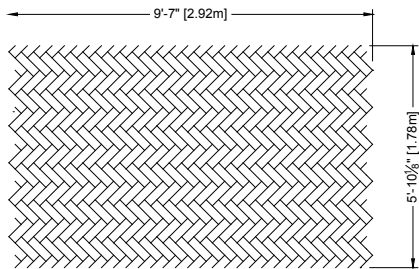

12-1-141 Diagonal Herringbone

SR-60 all sides all sides